

ELECTROLINE

Cat.# E-L 478

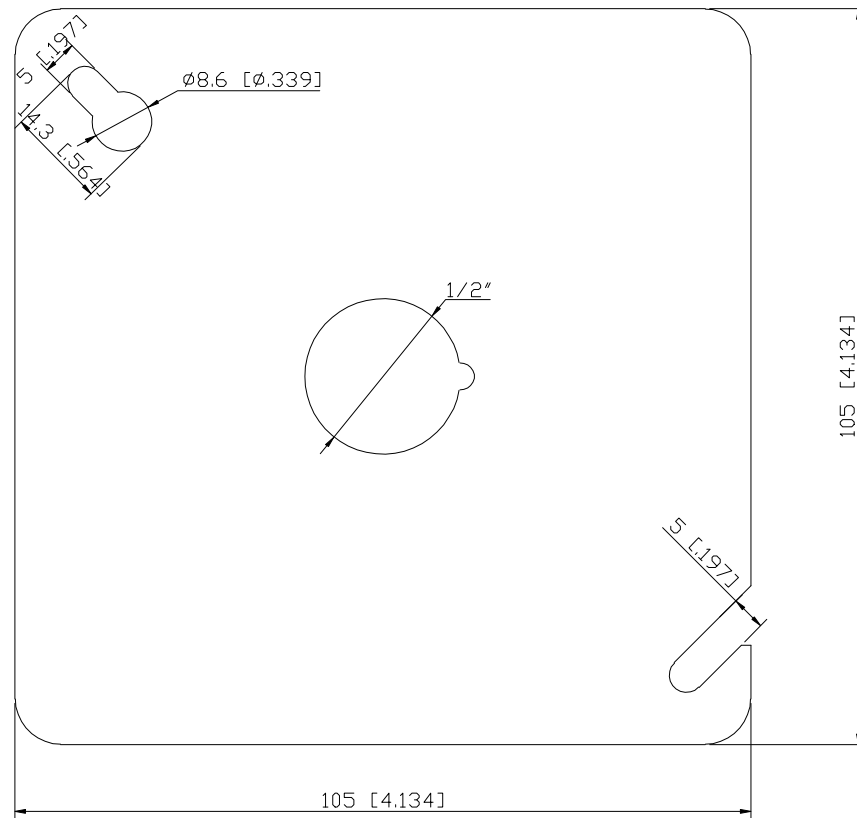
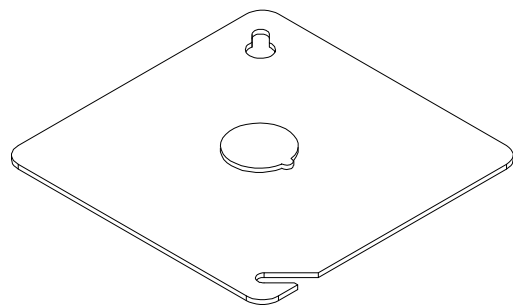

4" X 4"
1.6mm