

ELECTROLINE

Cat.# E-L 610

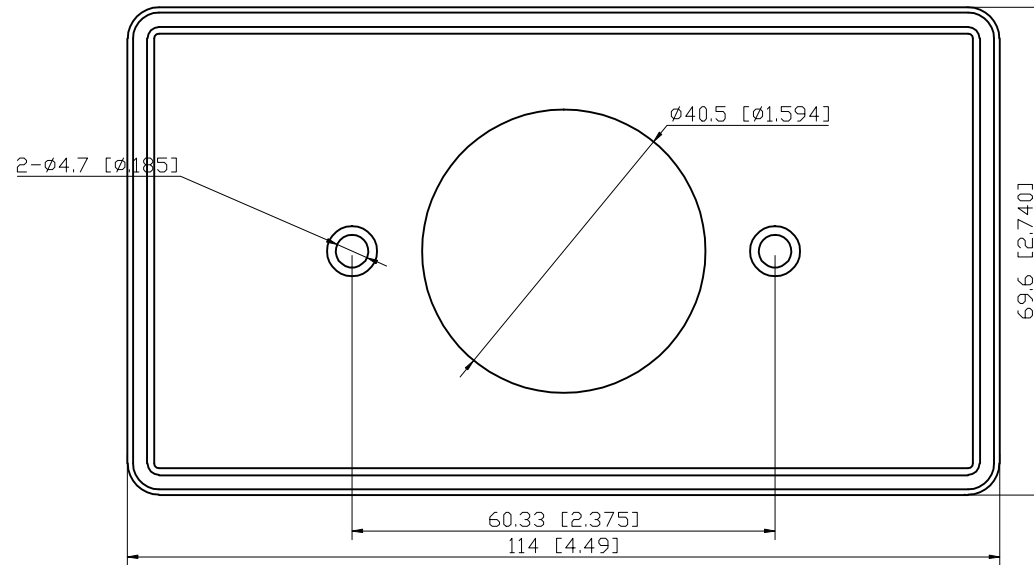

4" X 2"
0.8mm

